

Molecular Biology Basics

by Ahmet Sacan

> Overview of Molecular Biology

- Cell
- Macromolecules
- Central Dogma

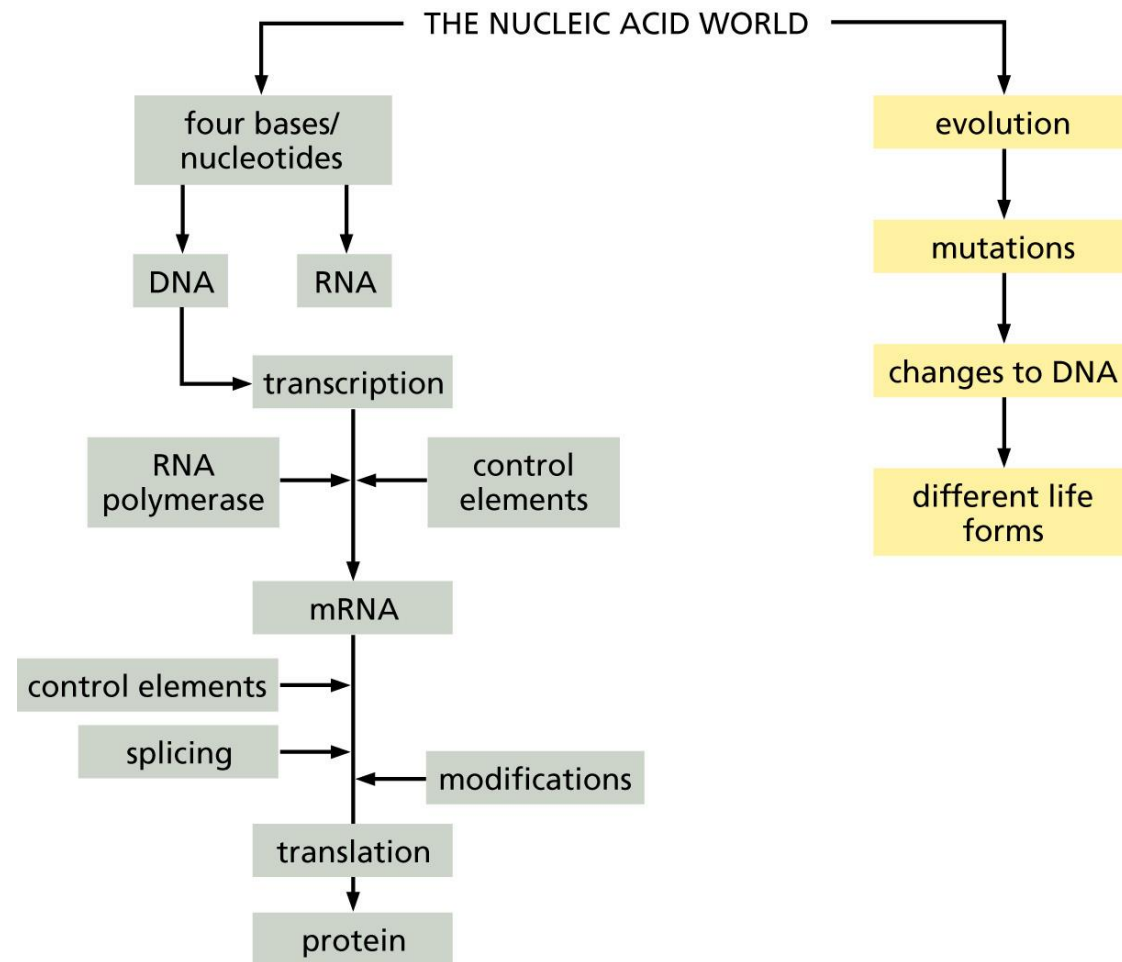

Living Organisms

- Entropy (a measure of disorder) always increases (2nd Law of Thermodynamics)
- Living organisms have low entropy, accomplished at the expense of increased entropy on the "outside"

Living Organisms

- "Entropy fighting machines"
- Functions of life facilitate:
 - acquisition and
 - orderly expenditure of energy
- Tasks:
 - Gather energy from environment
 - Use energy to maintain inside/outside
 - Use energy to reproduce
 - Develop strategies to perform above tasks efficiently

Macromolecules

- Lipids: Separate inside/outside
- Proteins, RNA: perform critical functions
- DNA: encode information about how/when to produce the above molecules

Central Dogma

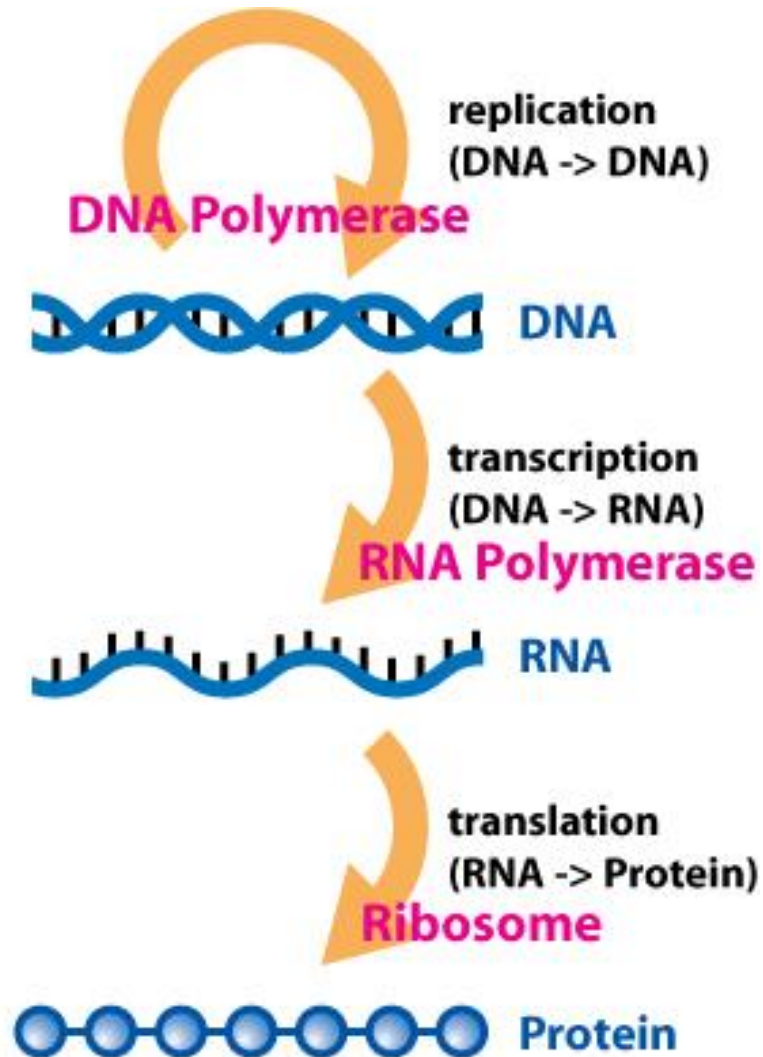

Central Dogma ++

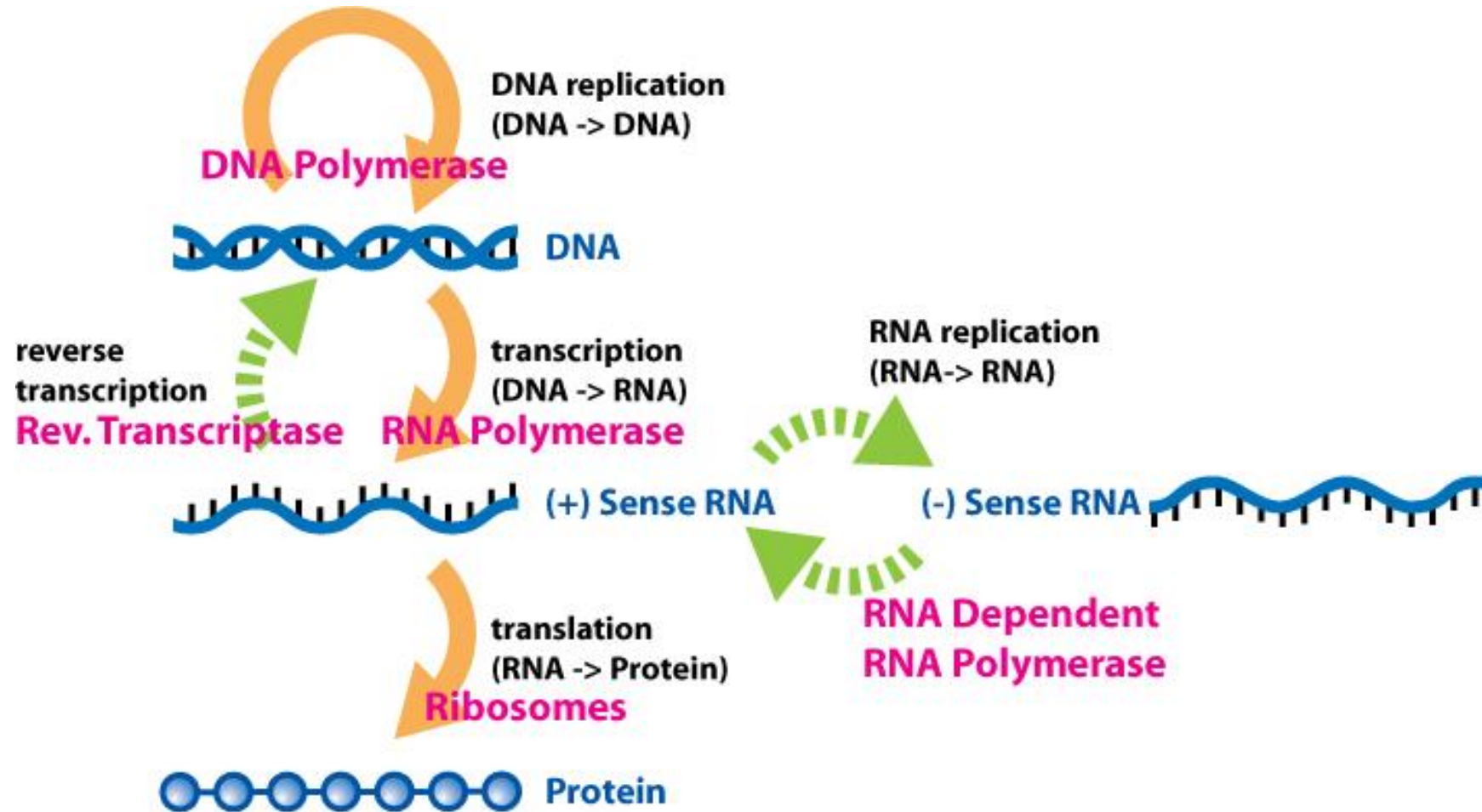

Nucleotide monomers

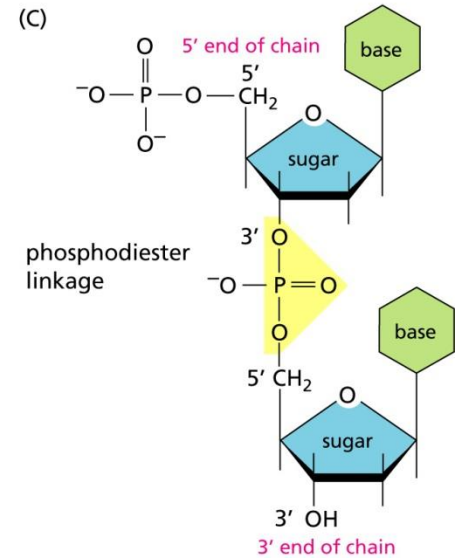
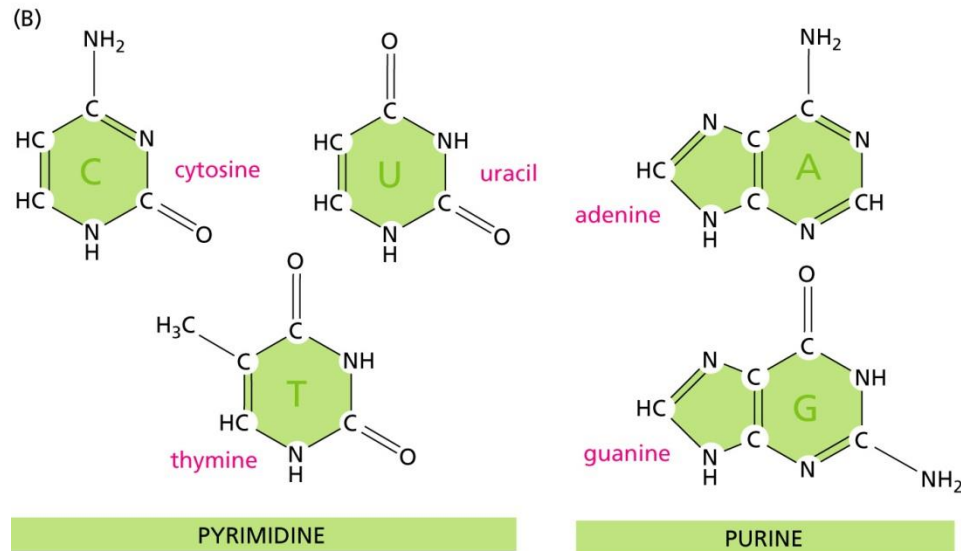
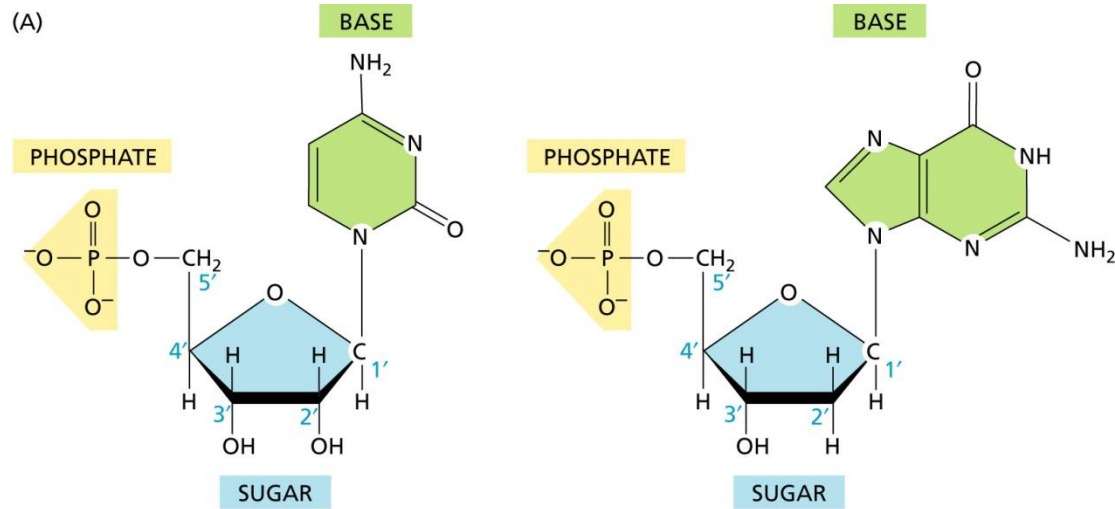
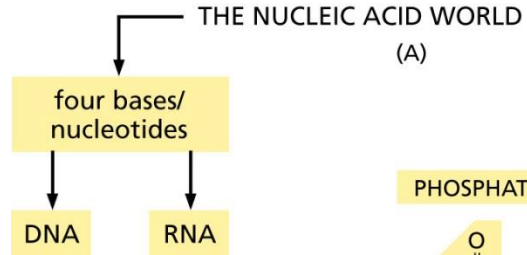

DNA

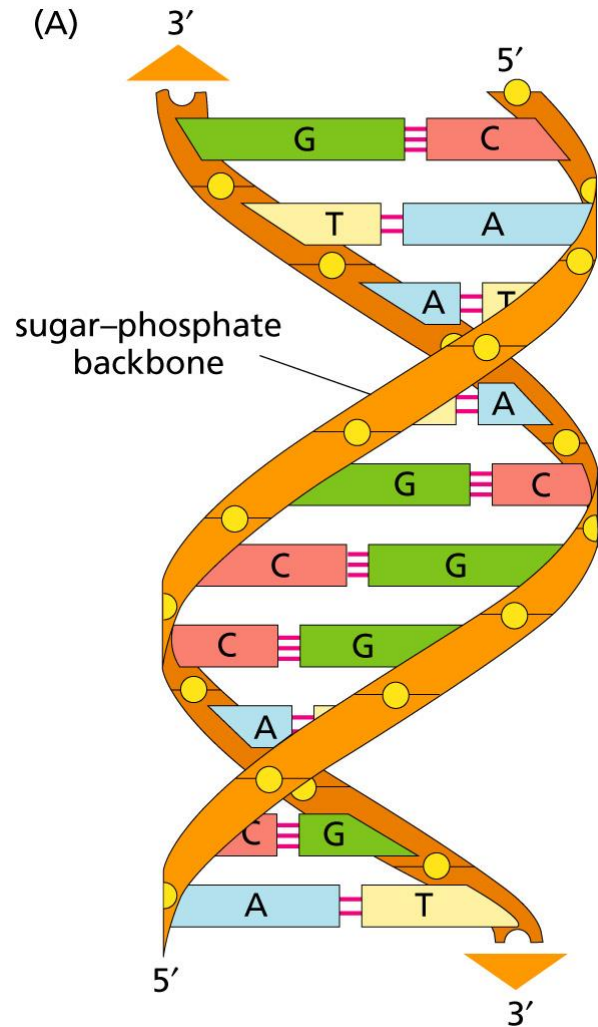

- *Watson-Crick base-pairing*

DNA

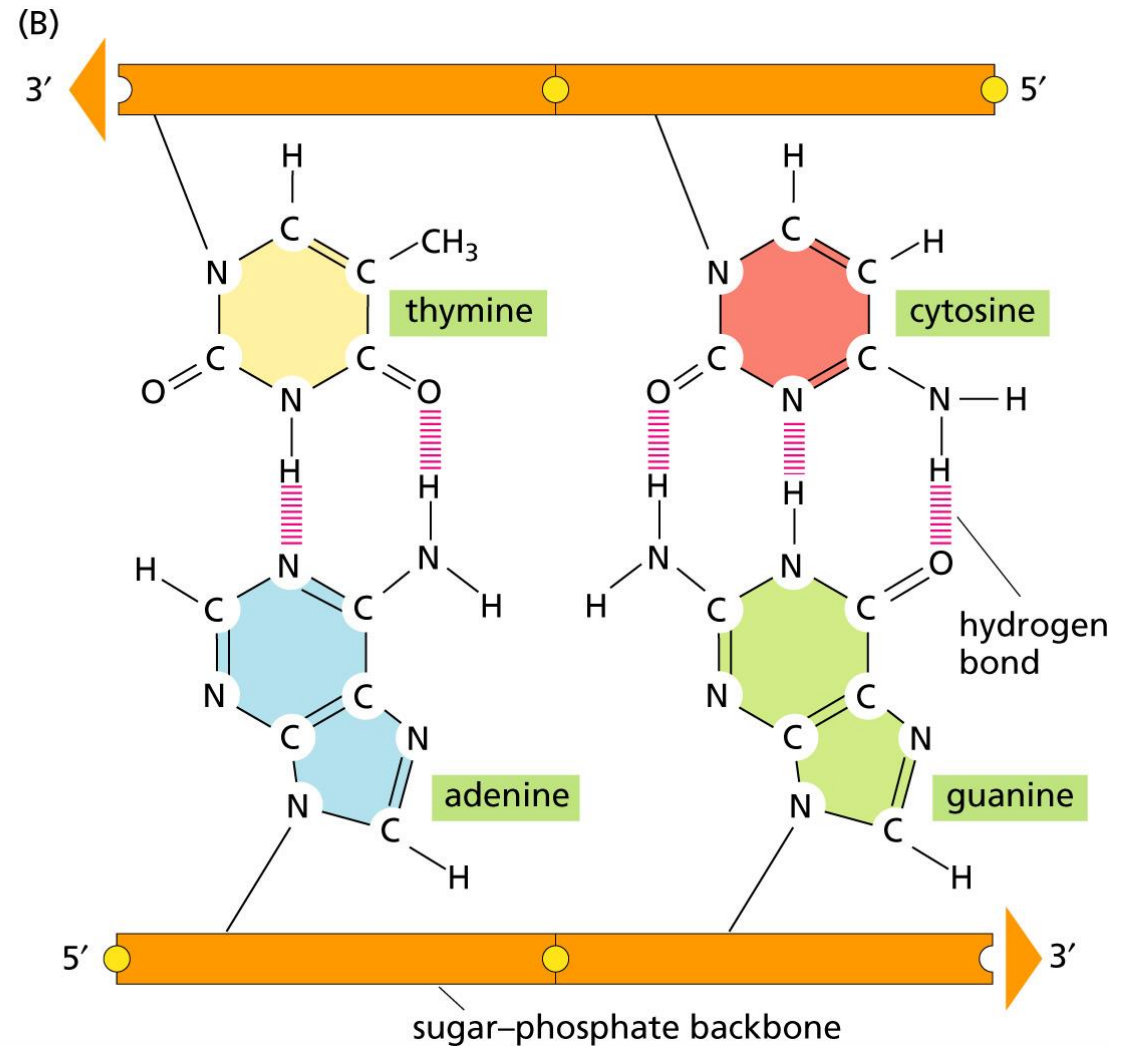
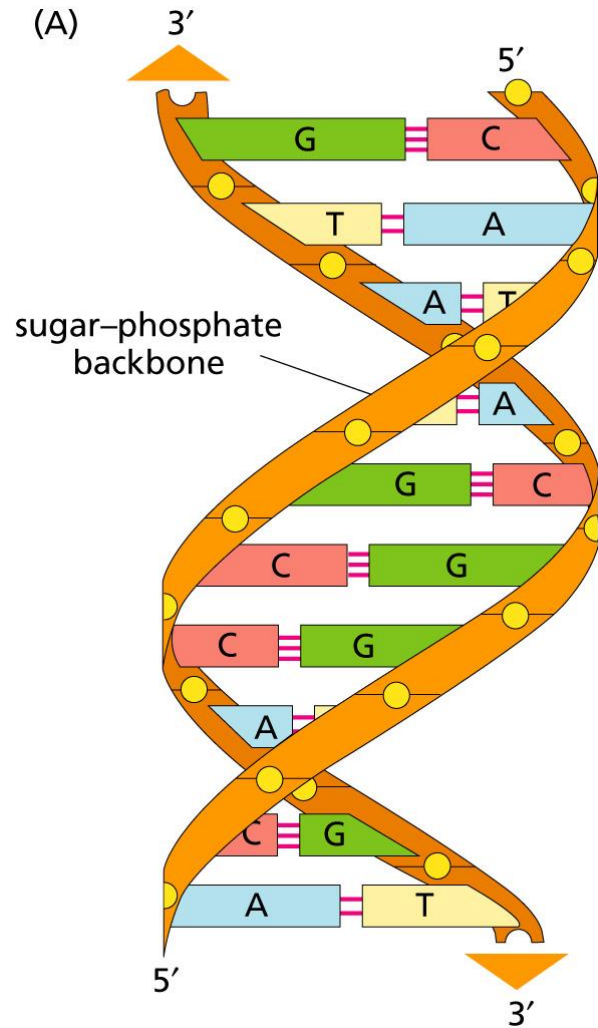

RNA

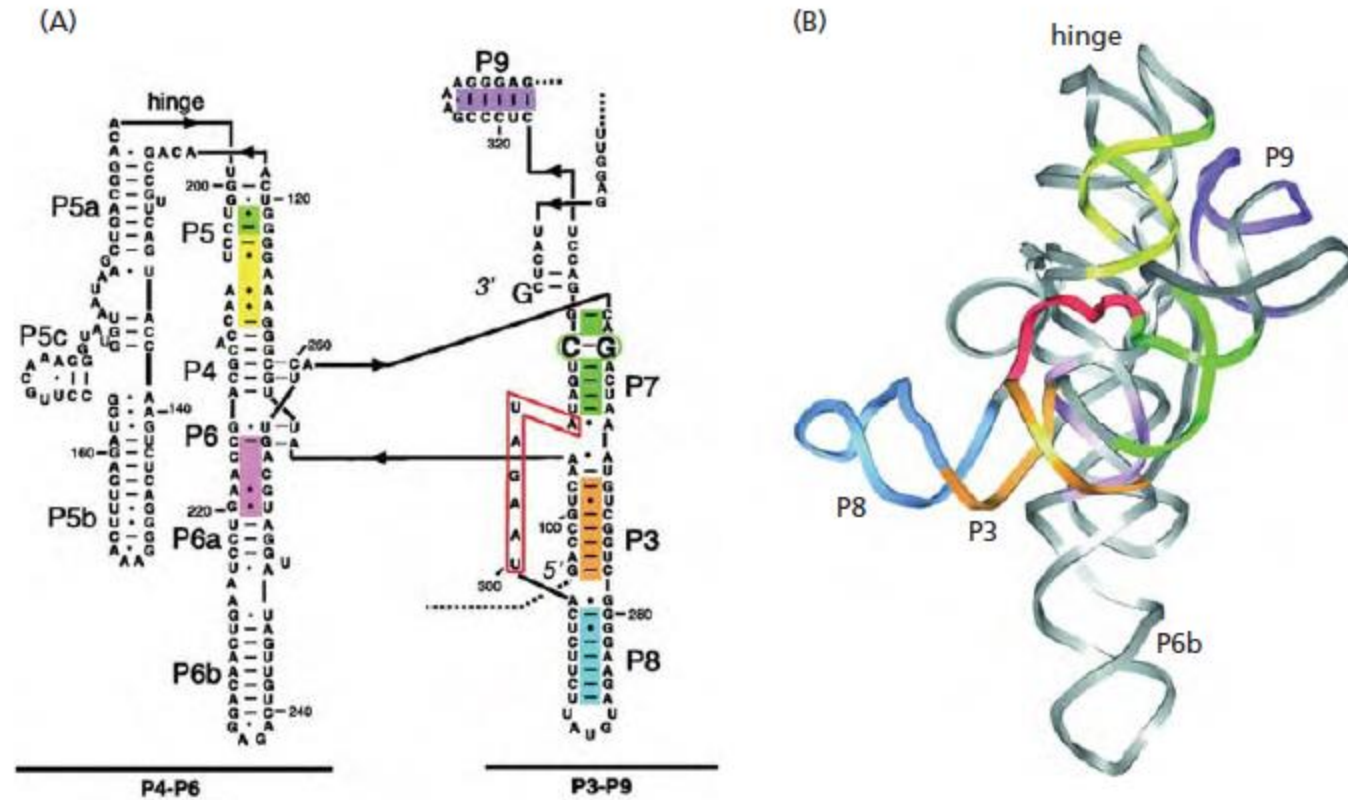

- Three dimensional structure of an RNA

DNA Replication

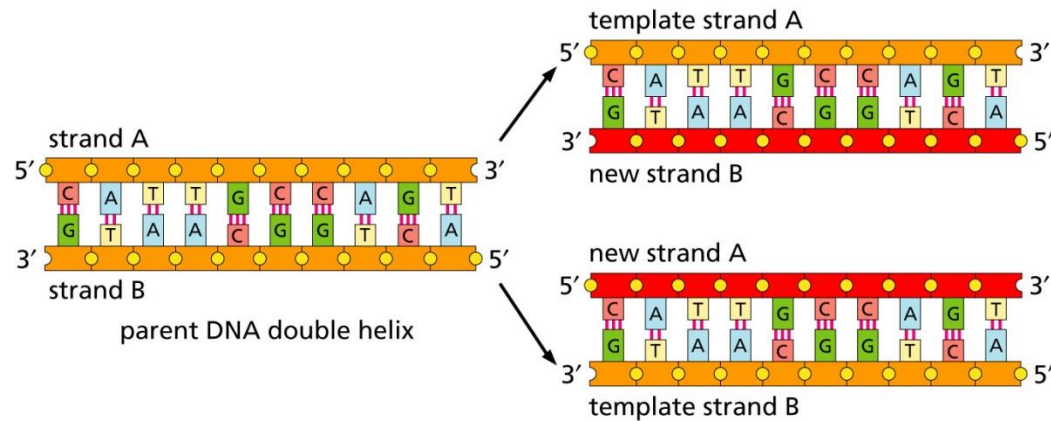

- Error rate: 1 in 10^9

Evolution

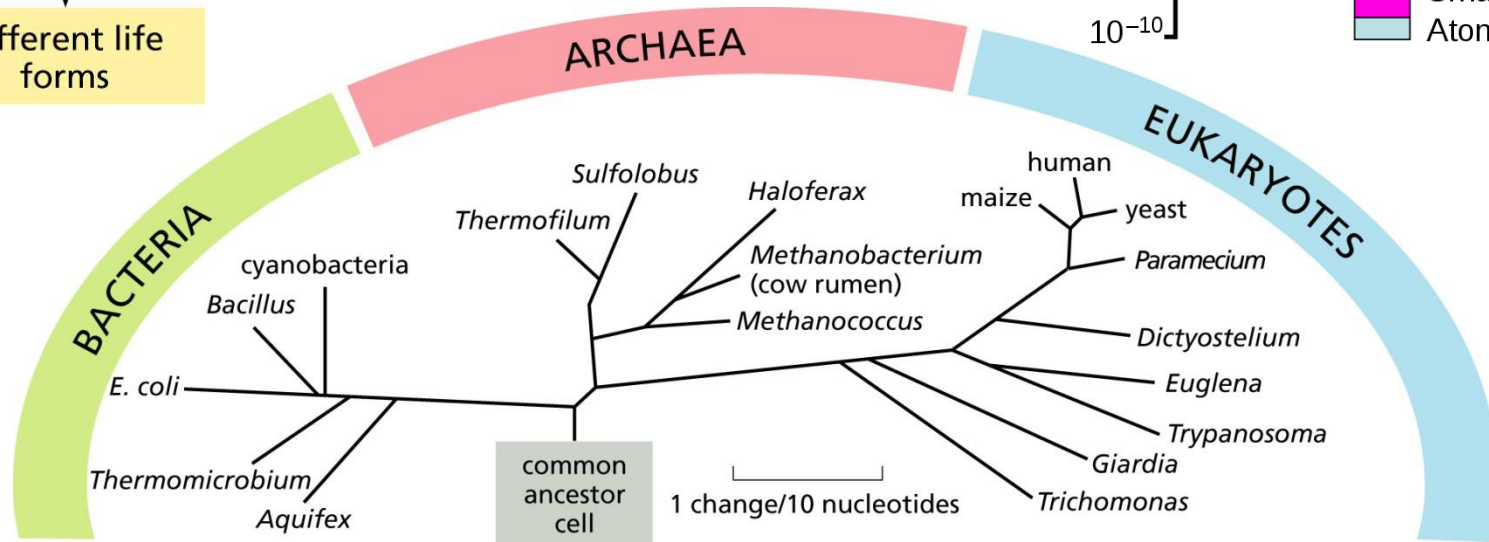
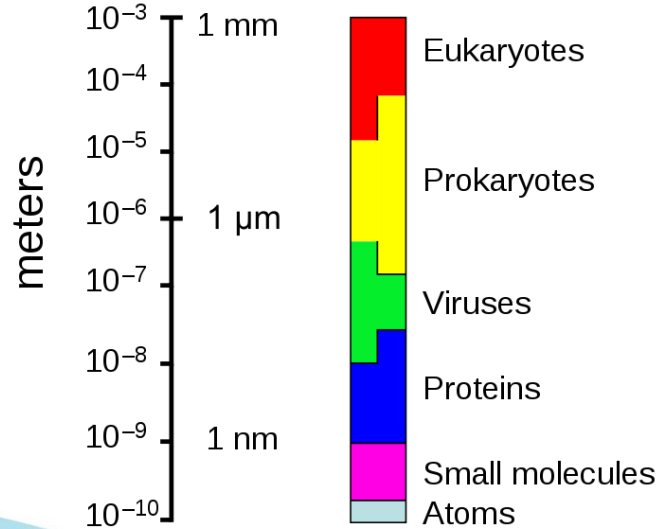
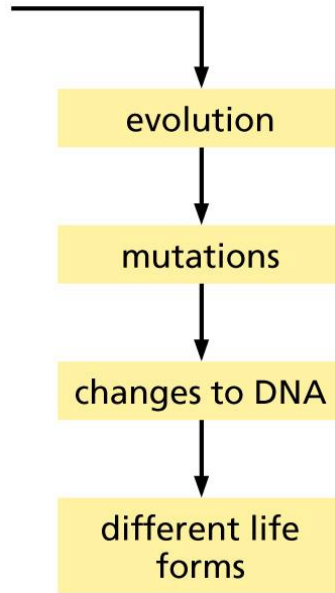

Prokaryotes

- No nucleus or organelles
- Single, circular chromosome
- Plasmids
 - Drug resistance
 - Rare compound metabolism
- Most studied: *Escherichia coli* (E. coli) - gut bacterium

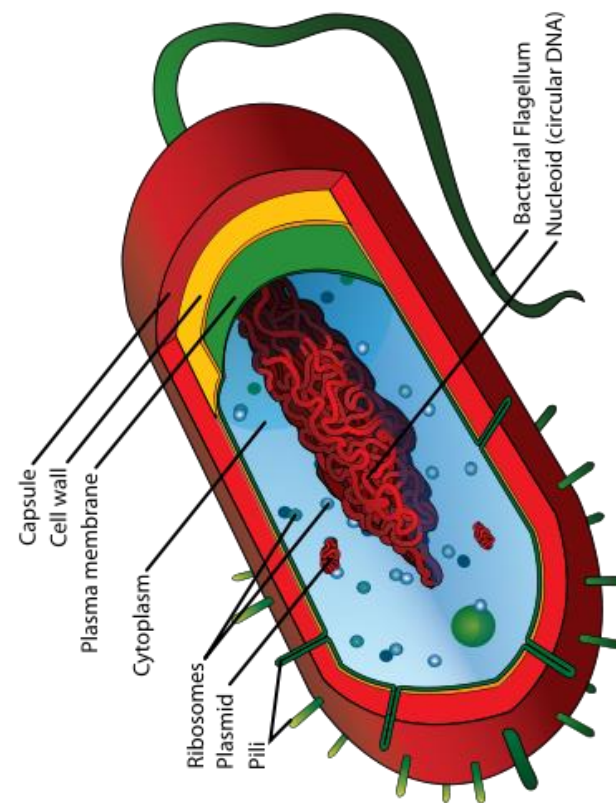

Eukaryotes

- Animals, plants, fungi, algae, protozoa
- Compartmentalized
 - nucleus, mitochondria, chloroplast
- Multiple linear chromosomes
 - Highly packed w/ histones

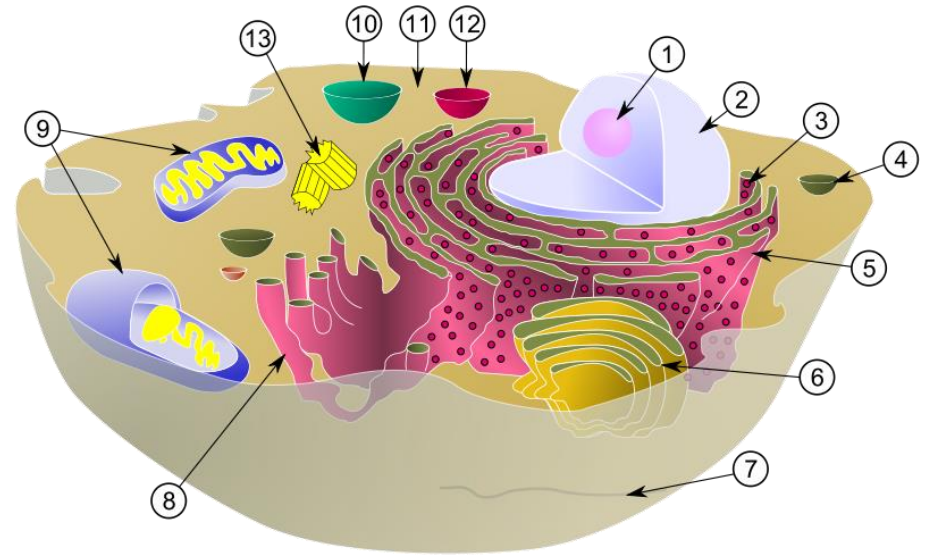

typical animal cell.

(1) nucleolus, (2) nucleus, (3) ribosome, (4) vesicle, (5) rough endoplasmic reticulum (ER), (6) Golgi apparatus, (7) Cytoskeleton, (8) smooth endoplasmic reticulum, (9) mitochondria, (10) vacuole, (11) cytoplasm, (12) lysosome, (13) centrioles within centrosome

Transcription

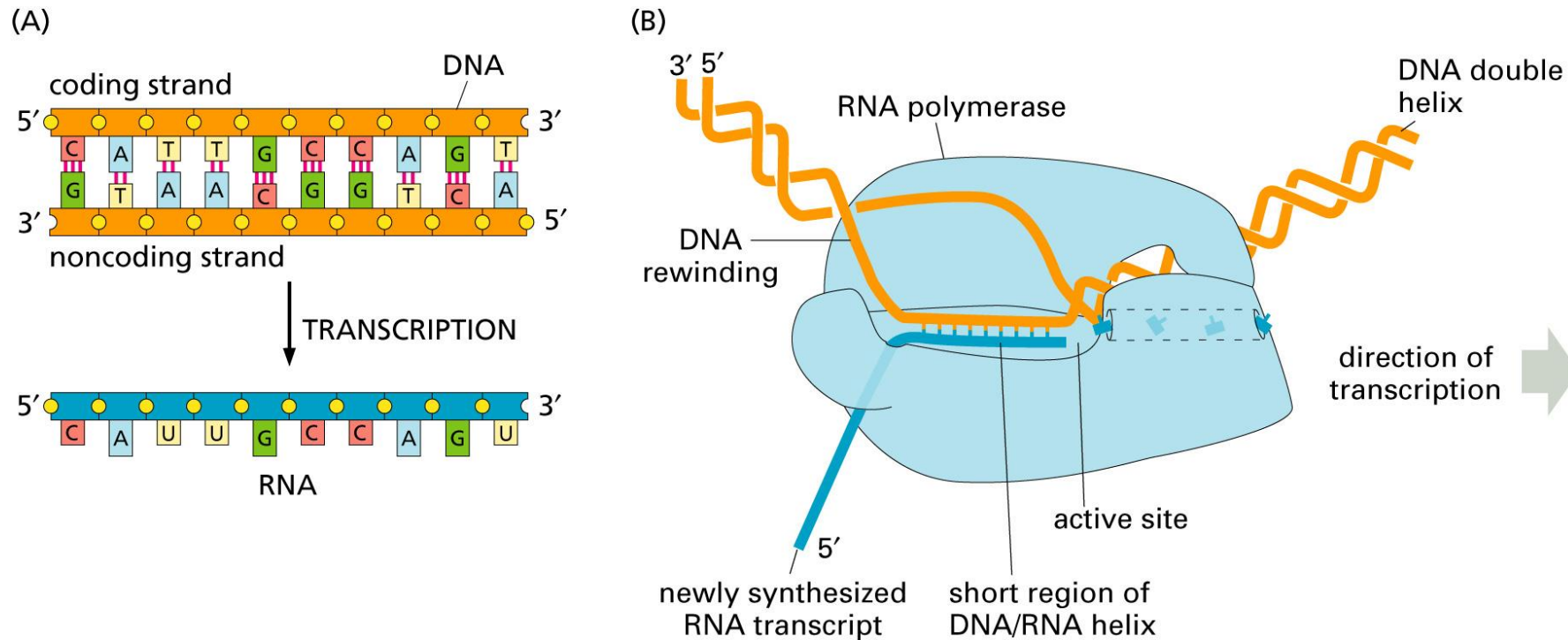

- Noncoding/anticoding/antisense strand serves as the physical template. Sequence of coding strand is identical to mRNA (except for T→U replacement).

Prokaryotic gene

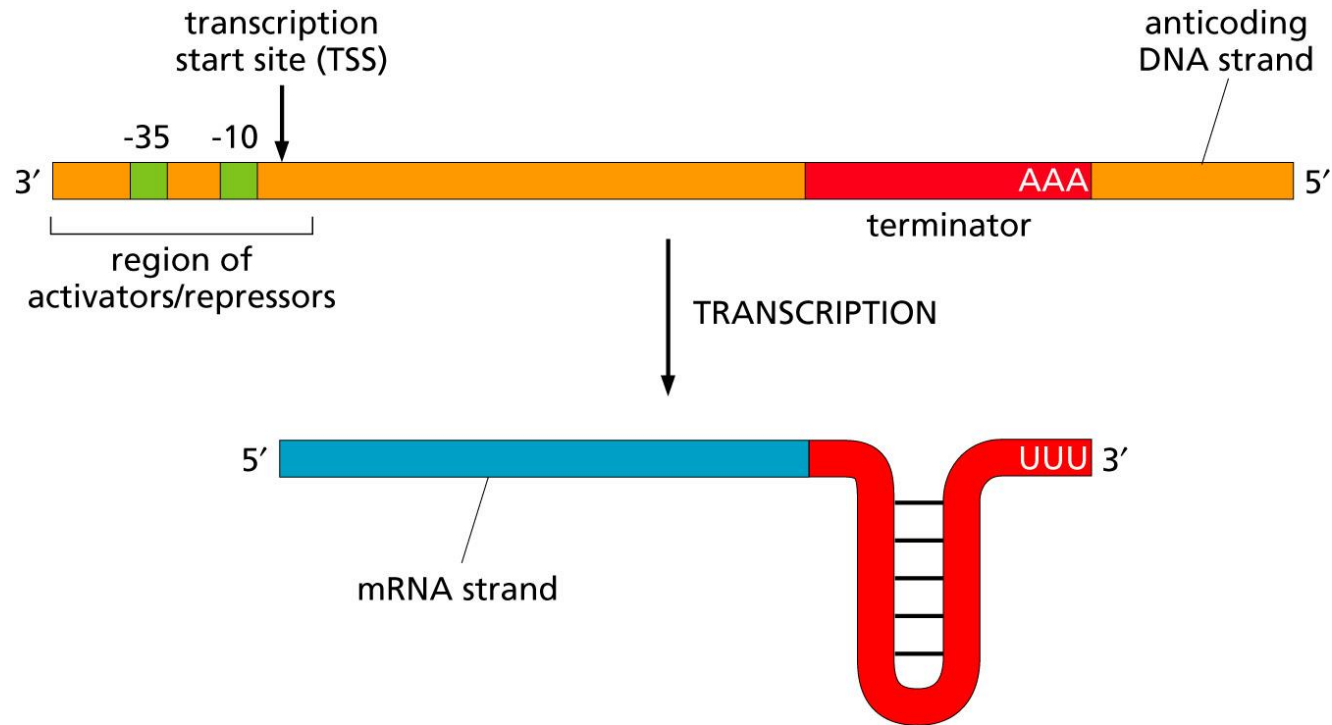

Eukaryotic gene

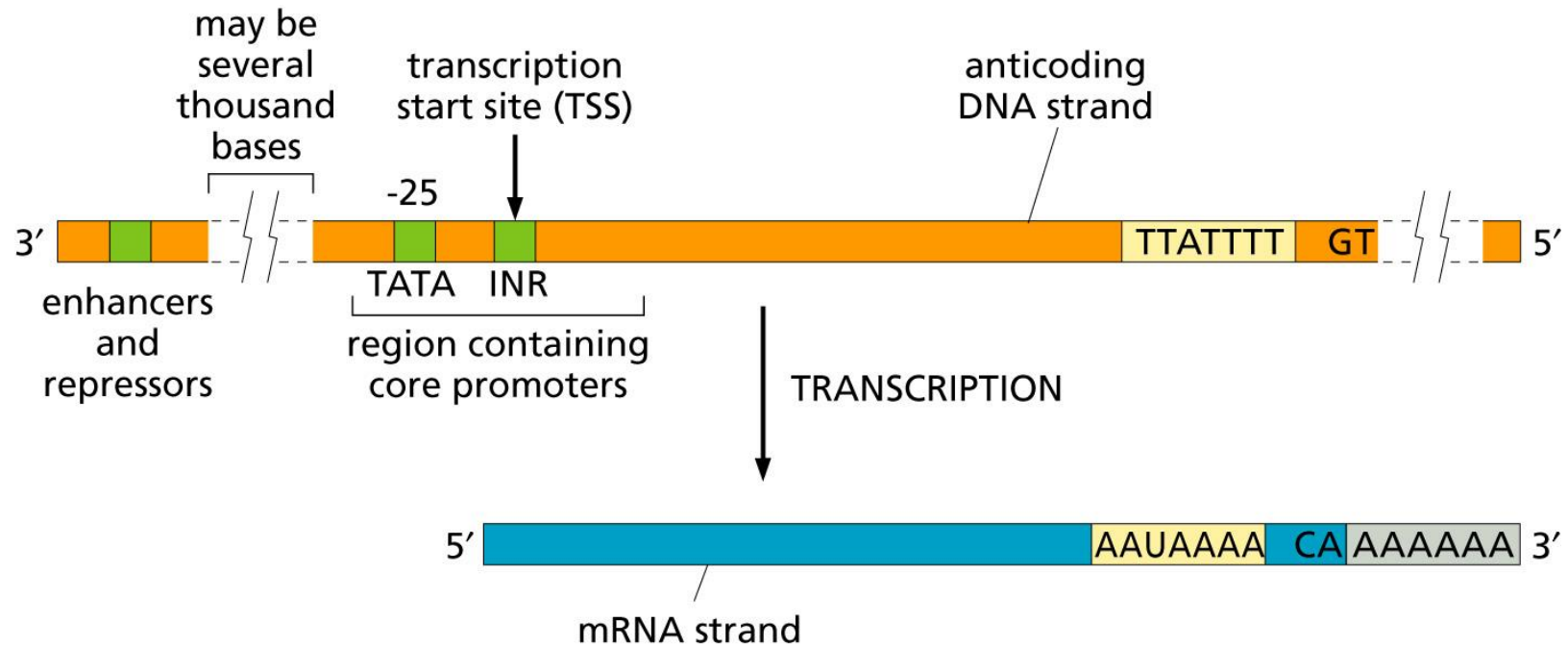

Eukaryotic gene

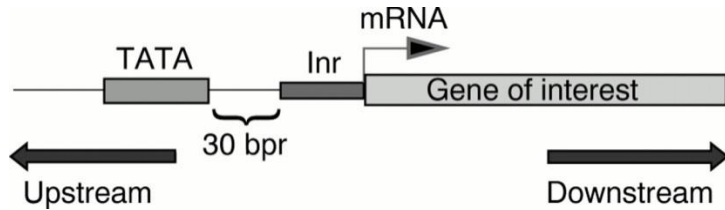

- Posttranscriptional modifications:
 - RNA capping (5'end)
 - Polyadenylation (~200xA at 3'end)
 - RNA splicing to remove introns - "alternative splicing"

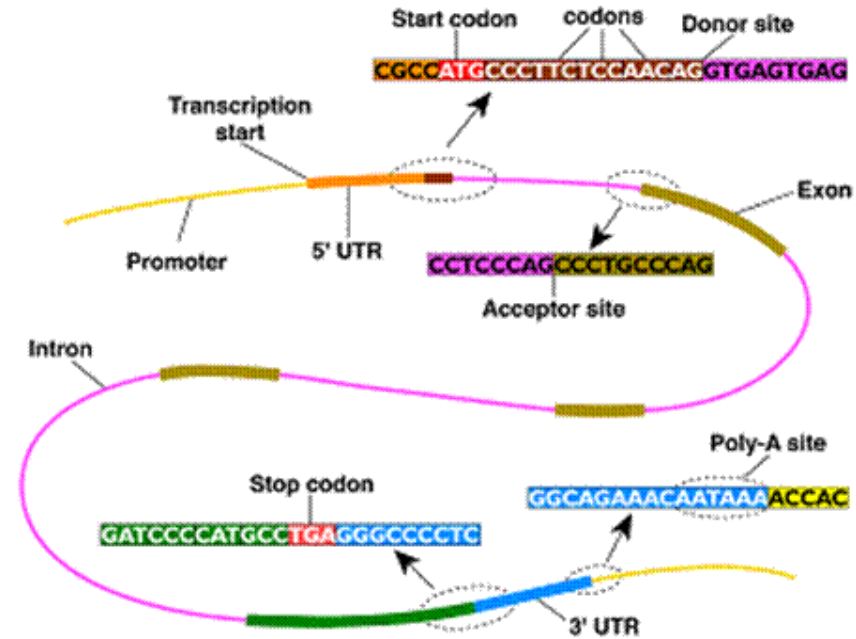

Eukaryotic mRNA

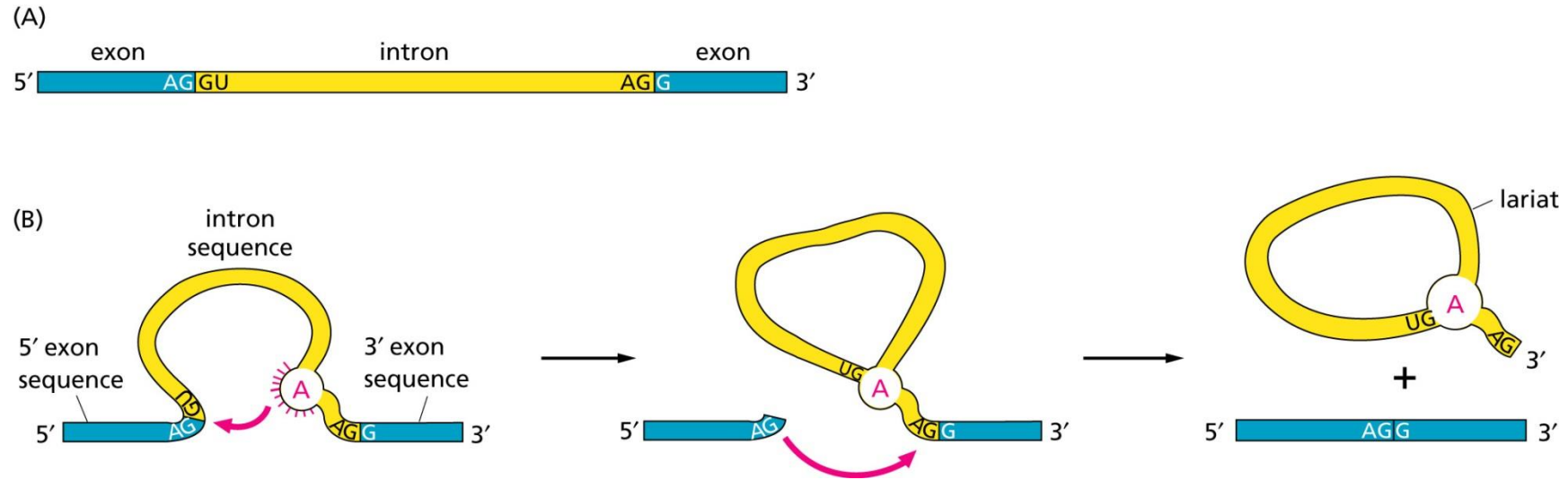

Open Reading Frame (ORF)

- 5' - CATACTAGATAATATTCGATTAAGC - 3'
- Frame 1:
 - CAT ACT AGA TAA* TAT TCG ATT AAG
- Frame 2:
 - ATA CTA GAT AAT ATT CGA TTA AGC
- Frame 3:
 - TAC TAG* ATA ATA TTC GAT TAA*

Overlapping ORFs, Operons

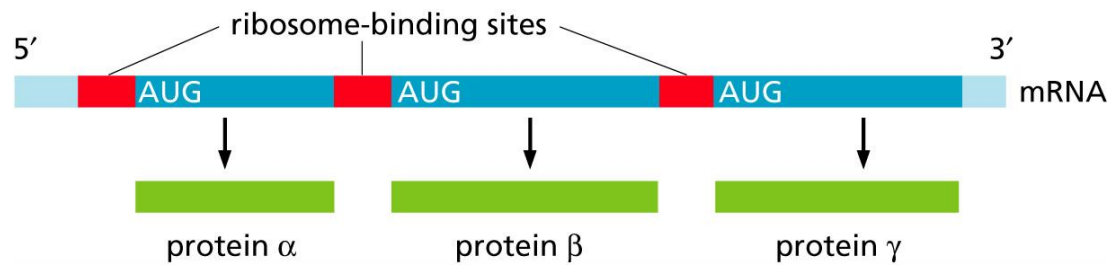
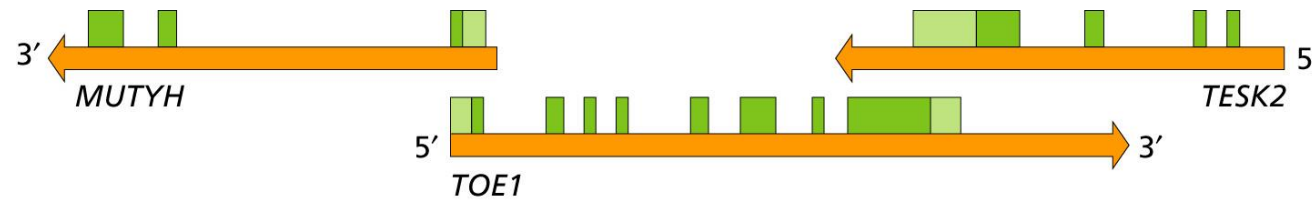

Lac operon

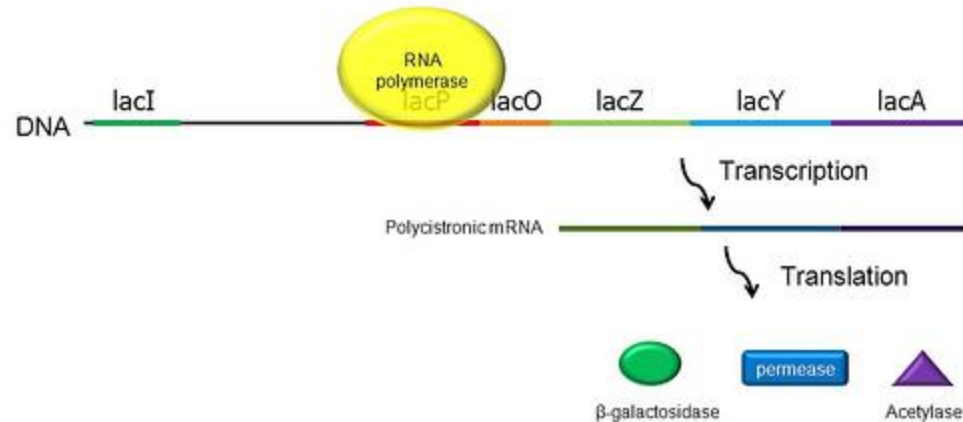

mRNA

- Coding Sequence: codons



1 5' CUC | AGC | GUU | ACC | AU 3'
—Leu—Ser—Val—Thr—

2 C | UCA | GCG | UUA | CCA | U
—Ser—Ala—Leu—Pro—

3 CU | CAG | CGU | UAC | CAU
—Gln—Arg—Tyr—His—

Translation initiation

- Bacteria:
 - Shine-Dalgarno sequence: a consensus AGGAGGU that appear upstream of AUG.
- Eukaryotes:
 - Ribosomal components bind 7-methylguanosine nucleotide at the 5' end and scan for an AUG codon.

Translation

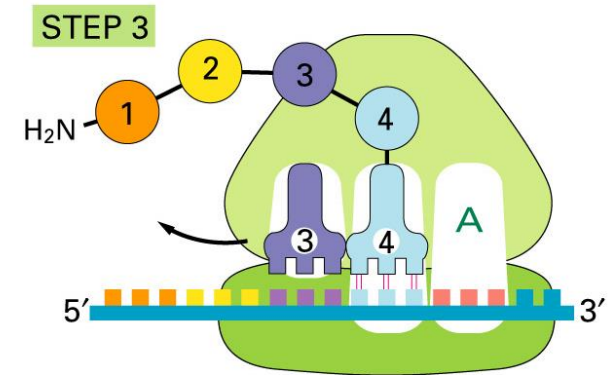
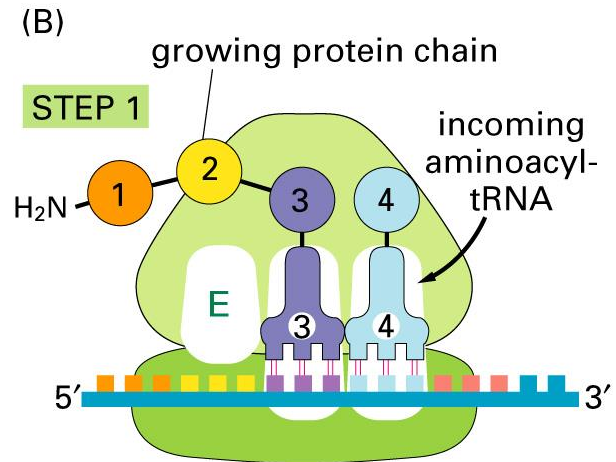
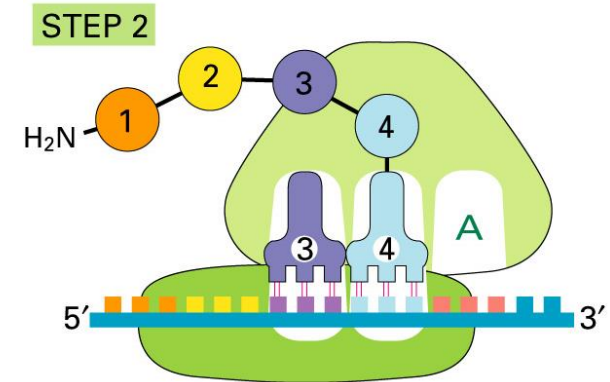
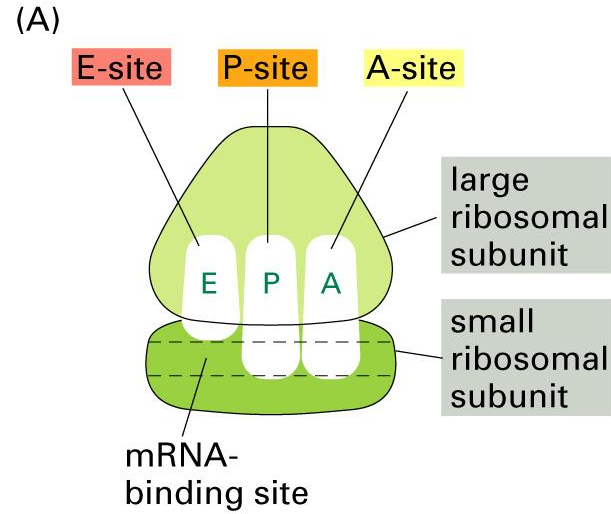

tRNA

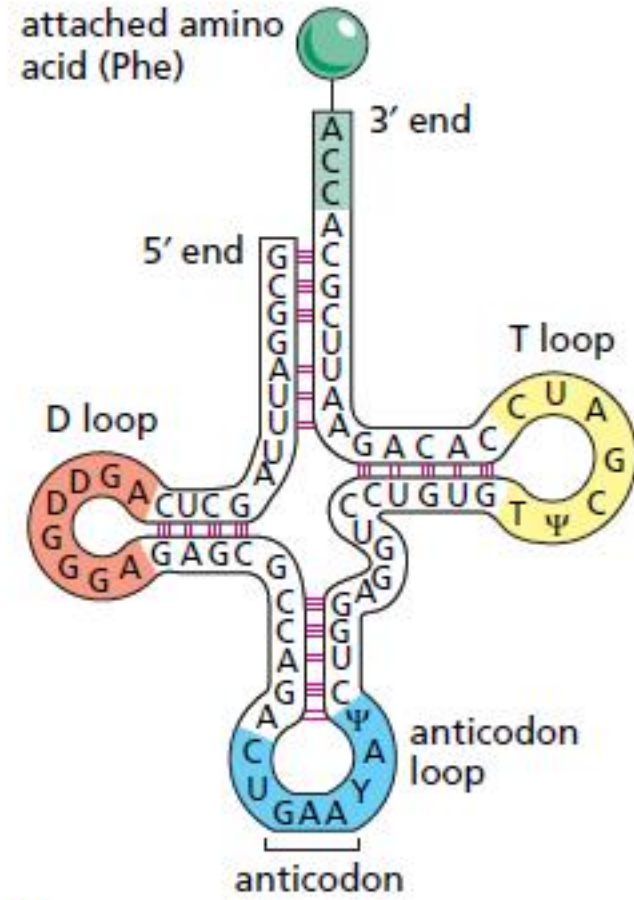

(A)

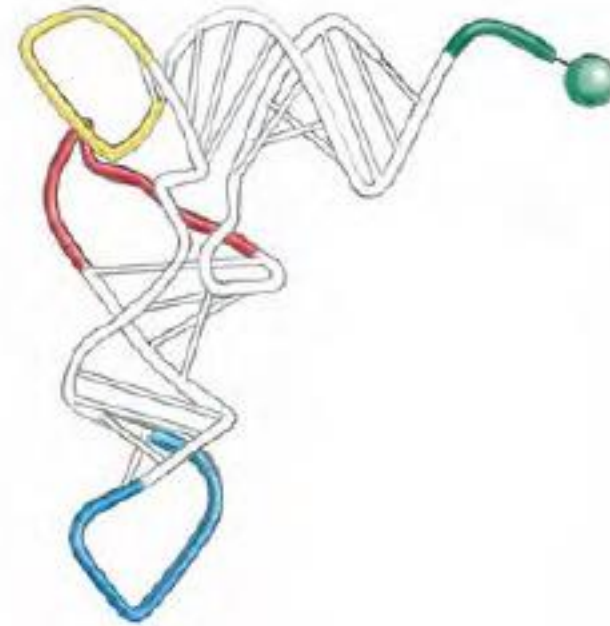

(B)

The Genetic Code

		Second letter				
		U	C	A	G	
First letter	U	UUU } Phe UUC } UUA } Leu UUG }	UCU } UCC } Ser UCA } UCG }	UAU } Tyr UAC } UAA Stop UAG Stop	UGU } Cys UGC } UGA Stop UGG Trp	U C A G
	C	CUU } CUC } Leu CUA } CUG }	CCU } CCC } Pro CCA } CCG }	CAU } His CAC } CAA } Gln CAG }	CGU } CGC } Arg CGA } CGG }	U C A G
	A	AUU } AUC } Ile AUA } AUG Met	ACU } ACC } Thr ACA } ACG }	AAU } Asn AAC } AAA } Lys AAG }	AGU } Ser AGC } AGA } Arg AGG }	U C A G
	G	GUU } GUC } Val GUA } GUG }	GCU } GCC } Ala GCA } GCG }	GAU } Asp GAC } GAA } Glu GAG }	GGU } GGC } Gly GGA } GGG }	U C A G

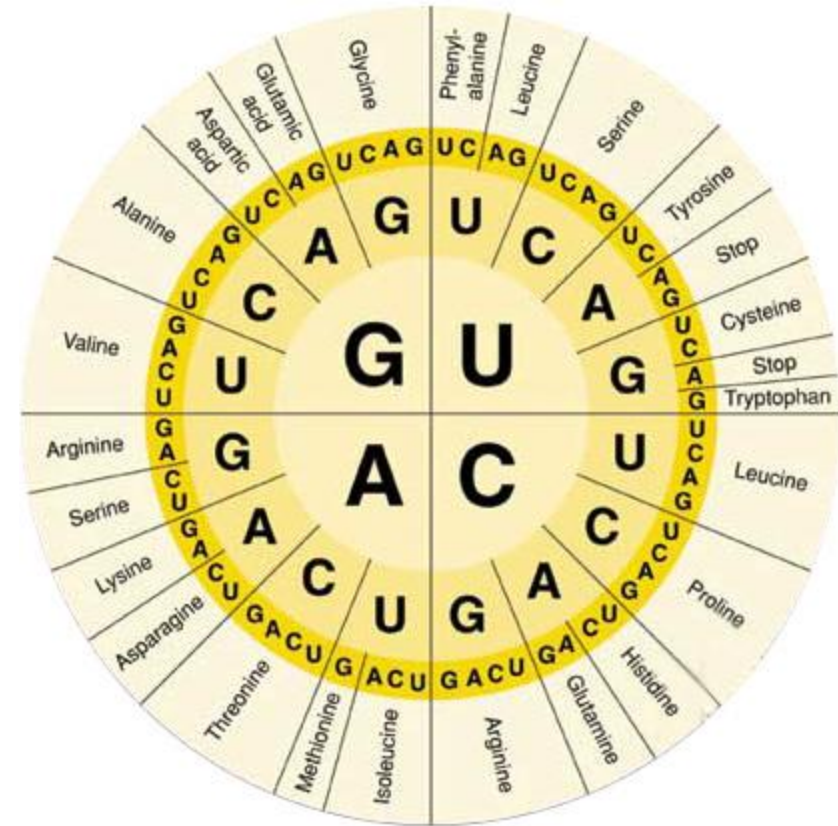

Summary

